

Model 200 Level Indicator Operation Manual

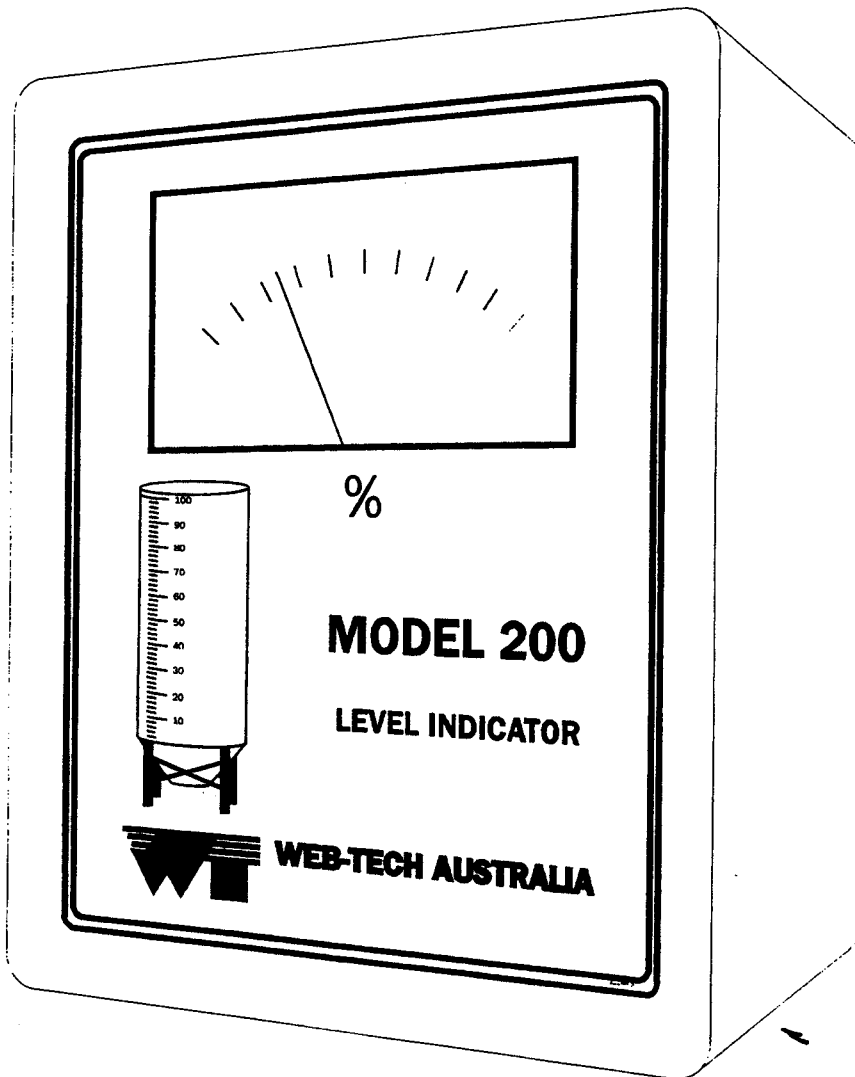

WEB-TECH AUSTRALIA

Head Office

WEB-TECH AUSTRALIA PTY LTD
11 Electronics Street,
EIGHT MILE PLAINS
BRISBANE. QLD. 4113

Postal Address

WEB-TECH AUSTRALIA PTY LTD
P.O. Box 4006,
EIGHT MILE PLAINS.
BRISBANE. QLD. 4113

Telephone: (07) 841 2844
Fax: (07) 841 0005
International: (617) 841 2844

Sydney Office

WEB-TECH AUSTRALIA PTY LTD
Suite 19,
16 Anella Avenue,
CASTLE HILL.
SYDNEY. NSW. 2154

Telephone: (02) 757 2296
Fax: (02) 899 6585

- (e) Use the  key to adjust the analogue meter until it indicates 0%. This effectively sets the auto-zero correction to 0%.
- (f) Press the green **ENTER** key **ONCE**. The microprocessor now sets the auto-zero correction factor to 0%.
- (g) Press the green **ENTER** key **ONCE** more. This causes the Model 200 to exit programming mode and return to its normal monitoring mode. The **Menu** display should resume scrolling at this point.

The auto-zero fault condition may be disabled by turning **OFF** the auto-zero facility. This procedure is described in Section 3.8.1. This procedure does not clear the fault as does the above routine, but merely hides it. The fault will re-emerge once the auto-zero facility is turned **ON**.

This concludes the auto-zero fault resetting routine.

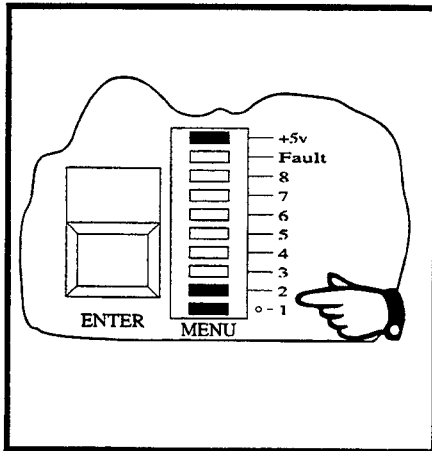

Figure 3-14
Auto-Zero Fault Reset Indicator on
Menu Display

mode and return to its normal monitoring mode. The **Menu** display should resume scrolling at this point.

This concludes the auto-zero maximum correction adjustment routine.

3.8.4 Resetting Auto-Zero Fault

Once the auto-zero fault condition has occurred, as described in Section 3.8.3, it must be manually cleared as described below. Resetting the auto-zero fault, deactivates the fault/status relay and clears the fault indication on the **Menu** display.

The procedure for clearing the auto-zero fault, is described below:

- (a) Turn **ON** the Model 200 mains switch. The **+5V** indicator LED on the **Menu** display should illuminate.
- (b) If a current auto-zero fault condition exists, the contacts of the status relay output on the Power Supply card should be open circuit and the **Menu** display should cease scrolling and the segments labelled **8, 7, 6** and **5** should be illuminated simultaneously. See Figure 3-13.
- (c) Press the blue **FUNCTION** key **ONCE**. The auto-zero fault indication on the **Menu** display should disappear and the segment labelled **1** should illuminate. Continue to press the **FUNCTION** key until the segments labelled **1** and **2** are illuminated simultaneously. This combination of segments identifies the auto-zero fault resetting function. See Figure 3-14.
- (d) Press the green **ENTER** key **ONCE**. This selects the auto-zero fault resetting function. The analogue meter should now display the current auto-zero correction setting. This indicates the deviation of the present system zero from the original system zero determined when the Zero and span Calibration was carried out.

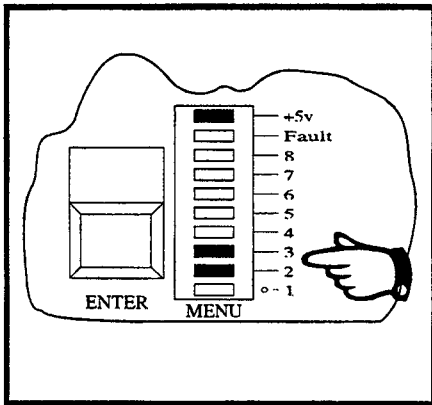

Figure 3-12
Auto-Zero Maximum Correction
Indicator on Menu Display

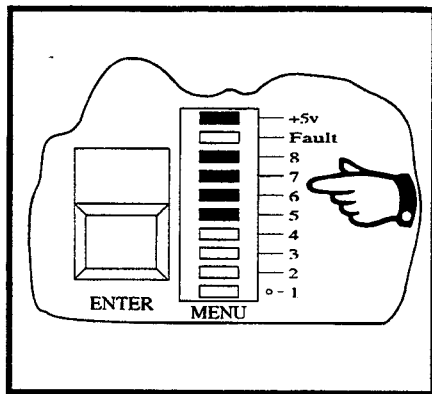

Figure 3-13
Auto-Zero Fault Indicator on Menu
Display

Should the accumulated correction exceed the maximum correction programmed into the instrument, the Model 200 will activate its fault/status relay providing a remote indication, while the **Menu** display on the CPU card will cease scrolling and display the auto-zero fault indication. See Figure 3-13.

The Model 200 will continue to provide bin level information when in this condition. The fault condition may be cleared by referring to Section 3.8.4 "Resetting Auto-Zero Fault".

The auto-zero maximum correction may be programmed into the Model 200 by following the procedure below:

- (a) Turn **ON** the Model 200 mains switch. The **+5V** indicator LED on the **Menu** display should illuminate.
- (b) Press the blue **FUNCTION** key **ONCE**. The **Menu** display should cease scrolling and the segment labelled **1** should illuminate. Continue to press the **FUNCTION** key until the segments labelled **2** and **3** are illuminated simultaneously. This combination of segments identifies the auto-zero maximum correction adjustment function. See Figure 3-12.
- (c) Press the green **ENTER** key **ONCE**. This selects the auto-zero maximum correction adjustment function. The analogue meter should now indicate the current auto-zero maximum correction setting.
- (d) Use the **↑** and **↓** keys to adjust the analogue meter until it indicates the desired auto-zero maximum correction level.

NOTE: Each press of the **↑** and **↓** keys corresponds to level change of 0.25%.

- (e) Press the green **ENTER** key **ONCE**. The microprocessor now stores the auto-zero maximum correction level just programmed.
- (f) Press the green **ENTER** key **ONCE** more. This causes the Model 200 to exit programming

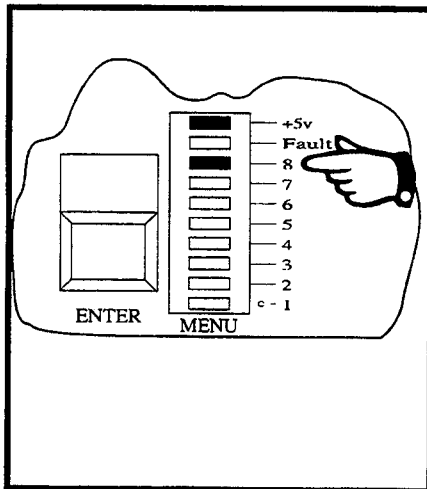





Figure 3-11
Auto-Zero Threshold Adjustment
Indicator on Menu Display

Continue to press the **FUNCTION** key until the segment labelled **8** illuminates. This segment identifies the auto-zero threshold adjustment function. See Figure 3-11.

- (c) Press the green **ENTER** key **ONCE**. This selects the auto-zero threshold adjustment function. The analogue meter should now indicate the current auto-zero threshold setting.
- (d) Use the  and  keys to adjust the analogue meter until it indicates the desired auto-zero threshold level.

Note: Each press of the  and  keys corresponds to a level change of 0.25%.

- (e) Press the green **ENTER** key **ONCE**. The microprocessor now stores the auto-zero threshold level just programmed.
- (f) Press the green **ENTER** key **ONCE** more. This causes the Model 200 to exit programming mode and return to its normal monitoring mode. The **Menu** display should resume scrolling at this point.

This concludes the auto-zero threshold adjustment routine.

3.8.3 Auto-Zero Maximum Correction Adjustment

The auto-zero function keeps a record of how far the present zero has deviated from the original zero which was determined during the Zero and Span calibration. Under normal circumstances this deviation or correction is quite small, however, under certain situations this correction may become quite sizeable. While a large correction does not necessarily indicate a fault condition, it does highlight a condition which warrants further investigation. The auto-zero maximum correction parameter allows the user to programme into the Model 200, what is considered to be the maximum allowable deviation before an investigation is warranted.

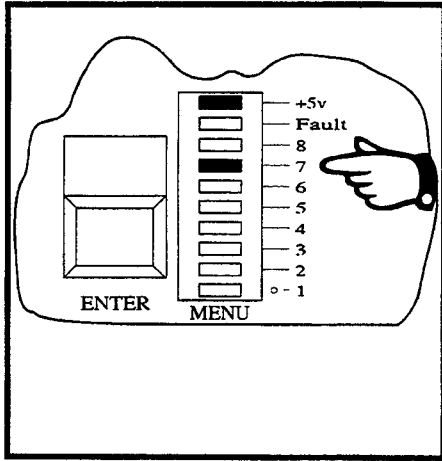



Figure 3-10
Auto-Zero ON/OFF Indicator on Menu
Display

press the **FUNCTION** key until the segment Z illuminates. See Figure 3-10.

- (c) Press the green **ENTER** key **ONCE**. This selects the auto-zero ON/OFF function. The analogue meter should now indicate the current status of the auto-zero function (ie: 0% indicates that the function is OFF, while 100% indicates that the function is ON).
- (d) Pressing either the  and  key causes the analogue meter to toggle between 0% and 100%. To enable the auto-zero function, set the analogue meter to 100%. To disable the auto-zero function, set the analogue meter to 0%.
- (e) Press the green **ENTER** key **ONCE**. The microprocessor now stores the information just entered into memory.
- (f) Press the green **ENTER** key once more. This causes the Model 200 to exit programming mode and return to its normal monitoring mode. The **Menu** display should resume scrolling at this point.

This completes the auto-zero on/off routine.

3.8.2 Auto-Zero Threshold Adjustment

Once enabled, the auto-zero function is performed only when the level in the storage vessel drops below a predetermined level and remains static for a period of time. This predetermined level is termed the auto-zero threshold. This threshold is normally set at quite a low level, but this will vary between applications.

The procedure for setting the auto-zero threshold is detailed below:

- (a) Turn **ON** the Model 200 mains switch. The **+5V** indicator LED on the **Menu** display should illuminate.
- (b) Press the blue **FUNCTION** key **ONCE**. The **Menu** display should cease scrolling and the segment labelled **1** should illuminate.

3.8. Auto-Zero Setup

The Model 200 is equipped, as standard, with an auto-zero facility. This facility enables the Model 200 to automatically adjust the system "zero" to compensate for changes in the storage vessel "empty" condition.

These changes could be due to a number of reasons, namely, the addition/removal of equipment to/from the vessel, modifications to the vessel or perhaps the most common is the build up of material on the exterior of the vessel. All of these occurrences can lead to erroneous bin level indications.

The auto-zero function works by sensing when the bin level has dropped below a user defined threshold. Should the bin level then remain static for a period of time, the Model 200 assumes that this now represents the new "empty" condition and removes any remaining offset. This operation is performed whenever the level in the storage vessel drops below the programmed threshold. The auto-zero function may be disabled at any time.

The Model 200 permits the entry of a maximum correction parameter. When the accumulated offset correction exceeds this parameter, the instrument activates the fault relay and displays the fault condition on the **Menu** display. The instrument will continue to provide bin level information when in this condition. The facility alerts the operator to the fact that the auto-zero function has accumulated a sizeable offset. While this does not necessarily indicate a system fault, it does highlight a situation which warrants further investigation. This fault condition requires manual resetting.

3.8.1 Auto-Zero ON/OFF

To turn the auto-zero facility on or off, perform the following procedure:

- (a) Turn **ON** the Model 200 mains switch. The **+5V** indicator LED on the **Menu** display should illuminate.
- (b) Press the blue **FUNCTION** key on the CPU card. The **Menu** display on the CPU card should cease scrolling and the segment labelled **1** should illuminate. Continue to

- (d) Press the blue **FUNCTION** key a number of times until the segment labelled **5** is illuminated. This segment identifies the 4mA calibration menu option. See Figure 3-2.
- (e) Press the green **ENTER** key **ONCE**. This selects the 4mA calibration function.
- (f) Adjust the **4mA adjust** potentiometer located on the CPU card, see Figure 3-3, until the external equipment connected to the current transmitter, indicates 0%.
- (g) Press the green **ENTER** key. The **Menu** display should commence scrolling. The Model 200 is now back in normal monitoring mode.
- (h) Press the blue **FUNCTION** a number of times until the segment labelled **6** on the **Menu** display illuminates. This segment identifies the 20mA calibration menu option. See Figure 3-4.
- (i) Press the green **ENTER** key **ONCE**. This selects the 20mA calibration function.
- (j) Adjust the **20mA adjust** potentiometer located on the CPU card, see Figure 3-3, until the external equipment connected to the current transmitter, indicates 100%.
- (k) Press the green **ENTER** key. The **Menu** display should commence scrolling. The Model 200 is now back in normal monitoring mode.

This completes the current transmitter alignment procedure. The adjustments made on the two potentiometers are non-interactive, therefore there is no need to repeat the process.

- (g) Repeat above process, if required, to programme remaining setpoint.

This concludes the setpoint programming routine.

3.7 4-20mA Current Transmitter Alignment

The Model 200 current transmitter has a facility to enable the current output to be *aligned* with any external equipment which may be connected. For example, occasionally even though the Model 200 produces a 4mA output, this fails to produce a zero indication on the auxiliary equipment connected. This anomaly does not necessarily indicate faulty equipment, but may be due to a number of factors including tolerancing and variations in calibration between the Model 200 and the devices connected. The Model 200 allows its current transmitter output to be *fudged* so as to eliminate these annoying discrepancies.

NOTE: It should be noted that aligning the current transmitter to the connected equipment, does not affect the calibration of the ZERO and SPAN or the setpoint operation. It does however, affect the calibration of the 4-20mA current transmitter.

To align the Model 200 current transmitter with the connected external equipment, follow the below instructions:

- (a) Ensure that the Model 200 is turned **OFF**.
- (b) Turn **ON** the Model 200 mains switch. The **+5v** indicator LED on the **Menu** display should illuminate.
- (c) Press the blue **FUNCTION** key on the CPU card of the Model 200. The **Menu** display on the CPU card should cease scrolling and the segment labelled **1** should illuminate.

For example, if a setpoint is programmed at 10% say, then the relay assigned to this setpoint will de-energize when the material level in the vessel drops to 10%. The relay will remain de-energized for all material levels below

this point. If the vessel is now filled, the relay will energise when the level in the bin reaches a value of 11%. This relay will stay energised as long as the bin level remains at this point or higher.

The procedure for programming both setpoint levels is identical, except for the differences highlighted.

To programme the setpoint levels, proceed as follows:

- (a) Turn **ON** the Model 200 mains switch. The **+5V** indicator LED on the **Menu** display should illuminate.
- (b) Press the blue **FUNCTION** key **THREE** times. The **Menu** display should cease scrolling and the segment labelled **3** should illuminate. This segment identifies the SP#1 menu function. See Figure 3-8. If you wish to programme SP#2, press the **FUNCTION** key **FOUR** times. The segment labelled **4** should illuminate. See Figure 3-9.
- (c) Press the green **ENTER** key **ONCE**. This selects either the SP#1 or SP#2 menu function. The analogue meter should indicate the present setting of the setpoint. Refer to Figures 3-8 and 3-9.
- (d) Use the **↑** and **↓** keys to adjust the analogue meter until it indicates the desired setpoint level.
- (e) Press the green **ENTER** key **ONCE**. The microprocessor now stores the setpoint level just programmed.
- (f) Press the green **ENTER** key **ONCE** more. This causes the Model 200 to exit programming mode and return to its normal monitoring mode. The **Menu** display should resume scrolling at this point.

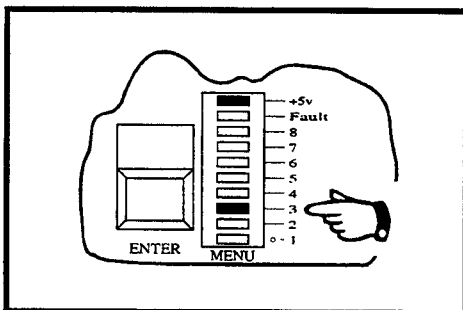

Figure 3-8
SP#1 Function Indicator on Menu Display

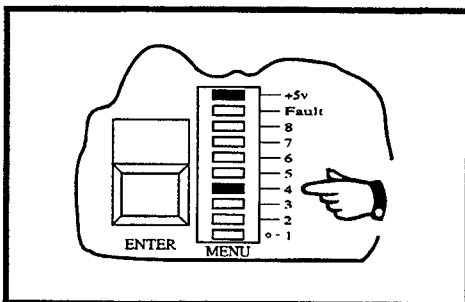

Figure 3-9
SP#2 Function Indicator on Menu Display

- (j) Press the green **ENTER** key **ONCE**. The microprocessor now reads the output of the load cell and relates this reading to the present level in the bin. This completes the ZERO setting procedure.
- (k) Press the green **ENTER** key **ONCE** more. This causes the Model 200 to exit programming mode and return to its normal monitoring mode. The **Menu** display should resume scrolling at this point.

This completes the ZERO and SPAN calibration routine.

The information obtained by the microprocessor during the ZERO and SPAN procedures, is now used to perform the internal calibration.

The Model 200 is now ready for use.

NOTE: The accuracy offered by the above procedures, can be increased by fine tuning. This fine tuning can be performed when the vessel becomes empty and/or full.

When the bin becomes empty, perform the ZERO procedure detailed in Section 3.3.1. When the bin becomes full, perform the SPAN procedure detailed in Section 3.3.2 .

Maximum system accuracy is obtained by performing both of the above fine tuning routines.

3.6 Programming of Setpoint Levels



The Model 200 offers two fully programmable setpoints as standard. These setpoints may be used to operate external equipment such as pump motors, alarms, etc., at pre-determined bin levels.

The operation of the setpoint relays was explained in *Section 2.4 Connecting the Setpoint Relay*, and is repeated here for clarity.

Once programmed, the setpoint relays de-energise when the bin level falls to or below their respective setpoint. The relays are energised only when the bin level rises to a point equal to or greater than their respective setpoint plus hysteresis. The default hysteresis value is set to 1% for the Model 200.

%	mA	%	mA
0	4	50	12
2	4.32	52	12.32
4	4.64	54	12.64
6	4.96	56	12.96
8	5.28	58	13.28
10	5.6	60	13.6
12	5.92	62	13.92
14	6.24	64	14.24
16	6.56	66	14.56
18	6.88	68	14.88
20	7.2	70	15.2
22	7.52	72	15.52
24	7.84	74	15.84
26	8.16	76	16.16
28	8.48	78	16.48
30	8.8	80	16.8
32	9.12	82	17.12
34	9.44	84	17.44
36	9.76	86	17.76
38	10.08	88	18.08
40	10.4	90	18.4
42	10.72	92	18.72
44	11.04	94	19.04
46	11.36	96	19.36
48	11.68	98	19.68
		100	20



Table 3-2
Bin Level Vs Current Output

- (c) Press the green **ENTER** key **ONCE**. This selects the SPAN menu function.
- (d) Estimate or measure the quantity of material currently contained in the storage vessel.
- (e) Use the  and  keys to adjust the analogue meter until it indicates the value determined in step (d) above. If neither of these keys is depressed at least once the function will not activate.
- (f) Press the green **ENTER** key **ONCE**. The microprocessor now reads the output of the load cell and relates this reading to the present level of material in the bin. This completes the SPAN setting procedure. If neither of the arrow keys has been used, the Model 200 will exit the function without changing the span.

The following operation relates to the ZERO setting procedure and needs to be carried out before the Model 200 can provide meaningful bin level information.

- (g) Remove a known quantity of material from the vessel. Determine the new level of material in the bin by subtracting the quantity just removed from the level - obtained in step (d) above.

NOTE: *The amount of material removed should be at least equal to 25% of the vessel capacity. This is necessary to obtain a reasonable level of accuracy.*

- (h) Press the blue **FUNCTION** key **ONCE**. The segment labelled 1 on the **Menu** display should illuminate. This segment identifies the ZERO menu function. See Figure 3-6.
- (i) Use the  and  keys to adjust the analogue meter until it indicates the storage vessel level determined in step (g) above. If neither of these keys is depressed at least once the function will not activate.

The information obtained by the microprocessor during the ZERO and SPAN procedures, is now used to perform the internal calibration.

The Model 200 is now ready for use.

NOTE: The accuracy offered by the above procedures, can be increased by fine tuning. This fine tuning can be performed when the vessel becomes empty and/or full.

When the bin becomes empty, perform the ZERO procedure detailed in Section 3.3.1. When the bin becomes full, perform the SPAN procedure detailed in Section 3.3.2 .

Maximum system accuracy is obtained by performing both of the above fine tuning routines.

3.5 ZERO and SPAN Calibration

(by removing a known quantity of material)

Ideally the ZERO and SPAN should be performed with an empty and full bin respectively. This affords the greatest level of accuracy. However, should the emptying and filling of the storage vessel for calibration not prove convenient and your application does not require high accuracy, then the following calibration procedure may be adopted.

This method of calibration may be *fine tuned* at a later date when the vessel does become empty or full through normal operation. This *fine tuning* will provide the same degree of accuracy as if the optimum calibration procedure in Section 3.3 had been followed.

Perform the ZERO and SPAN procedures as detailed below:



- (a) Turn **ON** the Model 200 mains switch. The **+5v** indicator LED on the **Menu Display** should illuminate.
- (b) Press the blue **FUNCTION** key **TWICE**. The **Menu** display should cease scrolling and the segment labelled **2** should illuminate. This segment identifies the SPAN menu function. See Figure 3-7.

- (f) Press the green **ENTER** key **ONCE**. The microprocessor now reads the output of the load cell and relates this reading to the present level of material in the bin. This completes the ZERO setting procedure. If neither of the arrow keys has been used the Model 200 will exit the function at this point without changing the span.

The following operation relates to the SPAN setting procedure and needs to be carried out before the Model 200 can provide meaningful bin level information.

- (g) Add a known quantity of material to the vessel. Determine the new level of material in the bin by adding the quantity just put in to the level obtained in step (d) above.

NOTE: The amount of material added should be at least equal to 25% of the vessel capacity. This is necessary to obtain a reasonable level of accuracy.

- (h) Press the blue **FUNCTION** key **ONCE**. The segment labelled **2** on the **Menu** display should illuminate. This segment identifies the SPAN menu function. See Figure 3-7.
- (i) Use the  and  keys to adjust the analogue meter until it indicates the value determined in step (g) above. Either of these keys must be depressed at least once to activate the function.
- (j) Press the green **ENTER** key **ONCE**. The microprocessor now reads the output of the load cell and relates this reading to the present level in the bin. This completes the SPAN setting procedure. If neither of the arrow keys has been used the Model 200 will exit the function at this point without changing the span.
- (k) Press the green **ENTER** key **ONCE** more. This causes the Model 200 to exit programming mode and return to its normal monitoring mode. The **Menu** display should resume scrolling at this point.

This completes the ZERO and SPAN calibration routine.

This completes the ZERO and SPAN calibration routine.

The information obtained by the microprocessor during the ZERO and SPAN procedures, is now used to perform the internal calibration.



The Model 200 is now ready for use.

3.4 ZERO and SPAN Calibration *(by adding a known quantity of material)*

Ideally the ZERO and SPAN should be performed with an empty and full bin respectively. This affords the greatest level of accuracy. However, should the emptying and filling of the storage vessel for calibration not prove convenient and your application does not require high accuracy, then the following calibration procedure may be adopted.

This method of calibration may be *fine tuned* at a later date when the vessel does become empty or full through normal operation. This *fine tuning* will provide the same degree of accuracy as if the optimum calibration procedure in Section 3.3 had been followed.

Perform the ZERO and SPAN procedures as detailed below:

- (a) Turn **ON** the Model 200 mains switch. The **+5v** indicator LED on the **Menu Display** should illuminate.
- (b) Press the blue **FUNCTION** key **ONCE**. The **Menu** display should cease scrolling and the segment labelled **1** should illuminate. This segment identifies the ZERO menu function. See Figure 3-6.
- (c) Press the green **ENTER** key **ONCE**. This selects the ZERO menu function.
- (d) Estimate or measure the quantity of material currently contained in the storage vessel.
- e) Use the  and  keys to adjust the current transmitter output until the analogue meter indicates the value determined in step (d) above. Either of these keys must be depressed at least once to activate the zero function.

vessel condition. This completes the ZERO setting procedure. If neither of the arrow keys have been depressed the Model 200 will exit the function at this point without changing the zero.

- (g) Press the green **ENTER** key **ONCE** more. This causes the Model 200 to exit programming mode and return to its normal monitoring mode. The **Menu** display should resume scrolling at this point.

3.3.2 SPAN Calibration

The following operation relates to the SPAN setting procedure and needs to be carried out before the Model 200 can provide meaningful bin level information.

- (a) Ensure that the bin is completely full.
- (b) Press the **FUNCTION** key **TWICE**. The LED segment labelled **2 ON** the **Menu** display should illuminate. This identifies the SPAN menu function. See Figure 3-7.
- (c) Press the green **ENTER** key **ONCE**. This selects the SPAN menu function.
- (d) Press and hold the red  key on the CPU card. Keep the key depressed until the analogue meter indicates 100%. Release the key. Either of the arrow keys must be depressed at least once to activate the span function.
- (e) Press the green **ENTER** key **ONCE**. The microprocessor now reads the output of the load cell and relates this reading to a full vessel condition. This now completes the SPAN setting procedure. If neither of the arrow keys has been used the Model 200 will exit the function at this point without changing the span.
- f) Press the green **ENTER** key **ONCE** more. This causes the Model 200 to exit programming mode and return to its normal monitoring mode. The **Menu** display should resume scrolling at this point.

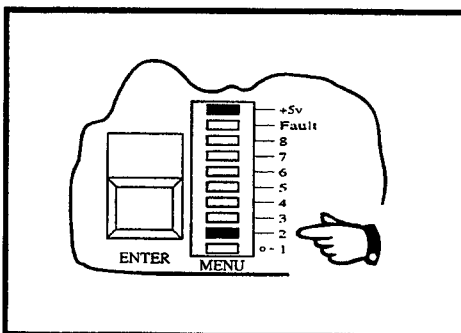

Figure 3-7
SPAN Function Indicator on Menu
Display

operation called SPAN, is performed when the vessel is full. This routine informs the microprocessor that the current load cell output corresponds to a full vessel.

The microprocessor uses these two pieces of information to determine the equation of the line passing through these two points. The Model 200 then uses this line equation to convert between load cell output and current bin level.

It is essential that both the ZERO and SPAN procedures be carried out, although the sequence in which they are performed is largely irrelevant.

NOTE: Before proceeding with the ZERO and SPAN calibration, carry out the 4-20mA Current Transmitter Calibration as detailed in Section 3.1 of this manual.

3.3.1 ZERO Calibration

Perform the ZERO operation as follows:

- (a) Turn **ON** the Model 200 mains switch. The **+5v** indicator LED on the **Menu Display** should illuminate.
- (b) Ensure that the storage vessel is empty.
- (c) Press the blue **FUNCTION** key. The **Menu** display should cease scrolling and the segment labelled **1** should illuminate. This segment identifies the ZERO menu function. See Figure 3-6.
- (d) Press the green **ENTER** key **ONCE**. This selects the ZERO menu function.
- (e) Press and hold the black  key on the CPU card. Keep the key depressed until the analogue meter indicates 0%. Release the key. Either of the arrow keys must be depressed at least once to activate the zero function.
- (f) Press the green **ENTER** key **ONCE**. The microprocessor now reads the output of the load cell and relates this reading to an empty

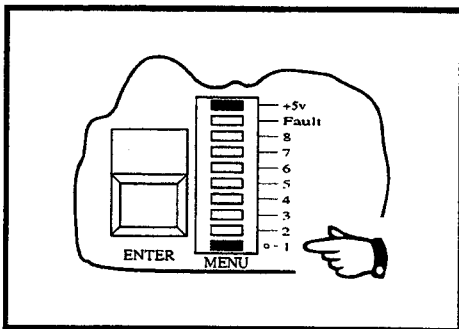

Figure 3-6
ZERO Function Indicator on Menu
Display

3.2 Load Cell Amplifier Gain Adjustment

The Model 200 provides load cell amplifier gains of unity and ten. This enables the device to accept a wide range of load cell outputs.

In most cases the Model 200 would use the unity gain setting thereby allowing input signals of up to 1 volt DC. However, where the load cell output under full load is less than about 1mV, then the (x10) gain setting is recommended.

The unit comes from the factory configured for unity gain, but the gain can be easily altered by positioning the links LK1, LK2 and LK4 on the CPU card, as detailed in Table 3-1 below. The location of these links is shown in Figure 3-5.

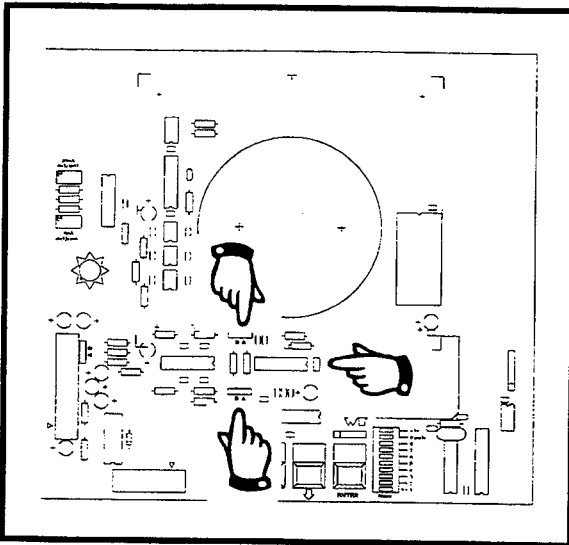

Figure 3-5
Location of Gain Links on CPU card

Link	x1 Gain	x10 Gain
LK1	 B A	 B A
LK2	 B A	 B A
LK4	 B A	 B A

Table 3-1
Amplifier Gain Link Settings

3.3 ZERO and SPAN Calibration (optimum)

This *optimum* procedure for setting the ZERO and SPAN parameters, provides the highest level of accuracy but can only be performed if you are prepared to completely empty and fill the storage vessel.

These two routines provide the Model 200 with two essential pieces of information. Firstly, the ZERO operation is performed when the storage vessel is empty. It tells the on board microprocessor that the current load cell output corresponds to an empty vessel. The second

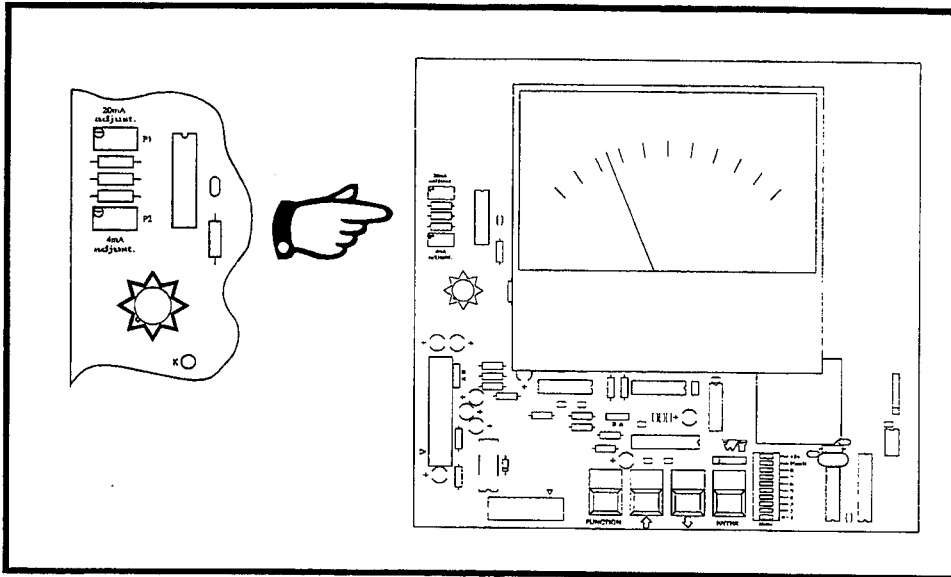

Figure 3-3
4mA and 20mA Adjustment
Potentiometers on CPU card

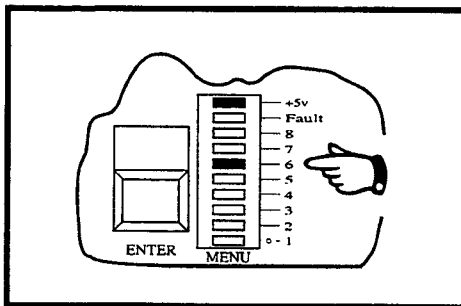

Figure 3-4
20mA Calibration Indicator on Menu
Display

- (i) Press the green **ENTER** key. The **Menu** display should commence scrolling. The Model 200 is now back in normal monitoring mode.
- (j) Press the blue **FUNCTION** a number of times until the segment labelled **6** on the **Menu** display illuminates. This segment identifies the 20mA calibration menu option. See Figure 3-4.
- (k) Press the green **ENTER** key **ONCE**. This selects the 20mA calibration function. The ammeter should indicate a reading of approximately 20mA.
- (l) Adjust the **20mA adjust** potentiometer located on the CPU card, see Figure 3-3, until the ammeter reads as close to 20mA as possible.
- (m) Press the green **ENTER** key. The **Menu** display should commence scrolling. The Model 200 is now back in normal monitoring mode.

This completes the current transmitter calibration procedure. The adjustments made on the two potentiometers are non-interactive, therefore there is no need to repeat the process.

3.1 4-20mA Current Transmitter Calibration

This procedure calibrates the 4-20mA current transmitter to ensure that the Model 200 outputs a current of 4mA when the storage vessel is empty, and a current of 20mA when the vessel is full. These parameters reflecting the requirements of the industry standard.

This procedure does not require the emptying or filling of the bin, as the signals representing these conditions are generated internally by the microprocessor.

To perform the current transmitter calibration, proceed as follows:

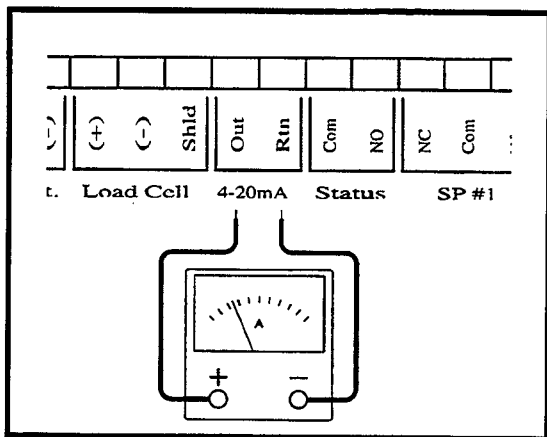

Figure 3-1
Connect Ammeter to 4-20mA Output.

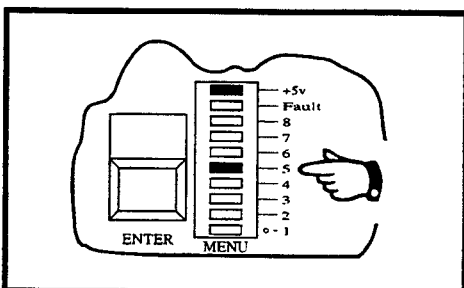

Figure 3-2
4mA Calibration Indicator on Menu Display

- (a) Ensure that the Model 200 is turned **OFF**.
- (b) Disconnect the 4-20mA output from any external equipment, if connected.
- (c) Connect an ammeter to the 4-20mA output terminals of the Model 200 as shown in Figure 3-1.
- (d) Turn **ON** the Model 200 mains switch. The **+5v** indicator LED on the **Menu** display should illuminate.
- (e) Press the blue **FUNCTION** key on the CPU card of the Model 200. The **Menu** display on the CPU card should cease scrolling and the segment labelled **1** should illuminate.
- (f) Press the blue **FUNCTION** key a number of times until the segment labelled **5** is illuminated. This segment identifies the 4mA calibration menu option. See Figure 3-2 .
- (g) Press the green **ENTER** key **ONCE**. This selects the 4mA calibration function. The ammeter should indicate a reading of approximately 4mA.
- (h) Adjust the **4mA adjust** potentiometer located on the CPU card, see Figure 3-3, until the ammeter reads as close to 4mA as possible.

3.0 Calibration Procedure

The Model 200 requires a simple calibration procedure be carried out to compensate for the variations which will invariably exist between different applications. An equally simple procedure allows the user to pre-programme the setpoint levels.

The calibration procedure which appears later in this chapter, would normally be carried out upon installation and commissioning of the level indicating system. Once performed, the calibration procedure need not be repeated unless one or more of the following events occur.

- (a) The original load cells used in the commissioning are replaced. Even though the load cells may be replaced with an identical part, their electrical characteristics may vary sufficiently to degrade the accuracy of the system.
- (b) The material in the storage vessel is replaced with another of a different bulk density. This change in bulk density, will result in the load cell output being offset by an amount directly proportional to the variation in the bulk densities.
- (c) The Model 200 is removed from the original application site and re-installed on a different application. This shift invariably means different materials, different load cells and a different storage vessel, all of which can affect system accuracy.

The procedure for programming the setpoints, on the other hand, need only be repeated when the user wishes to alter the setpoint levels.

The calibration procedure consists of a number of short simple routines. The first of these calibrates the 4-20mA current transmitter output. The second set of routines known as ZERO and SPAN, calibrates the Model 200 to accommodate the characteristics of the particular application. While the final procedure allows the user to adjust the current transmitter output to *align* it with other equipment in the system. Each of these routines is explained in more detail in the following text.

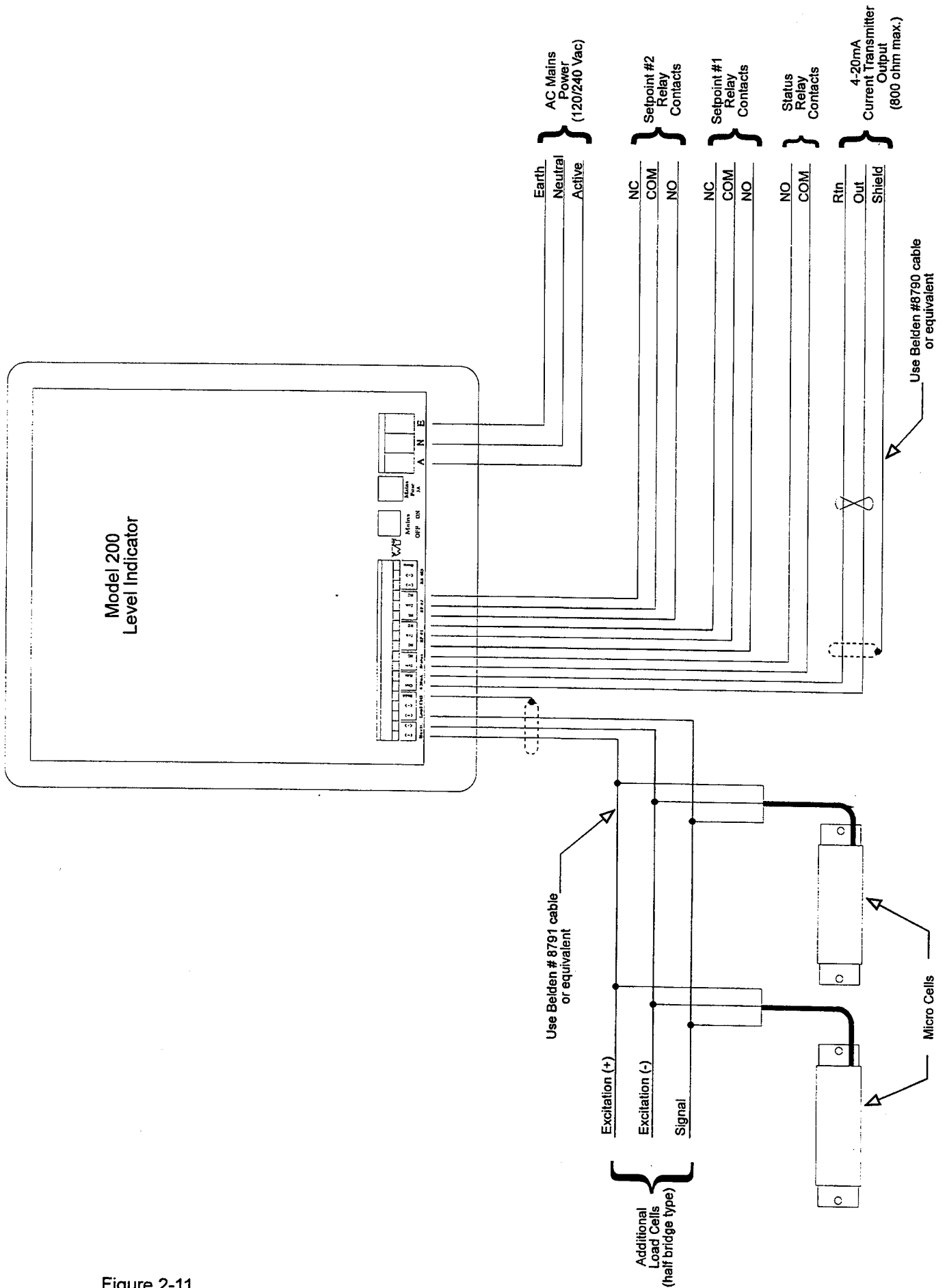

Figure 2-11

Model 200 Wiring Interconnect Diagram
(when using MicroCells)

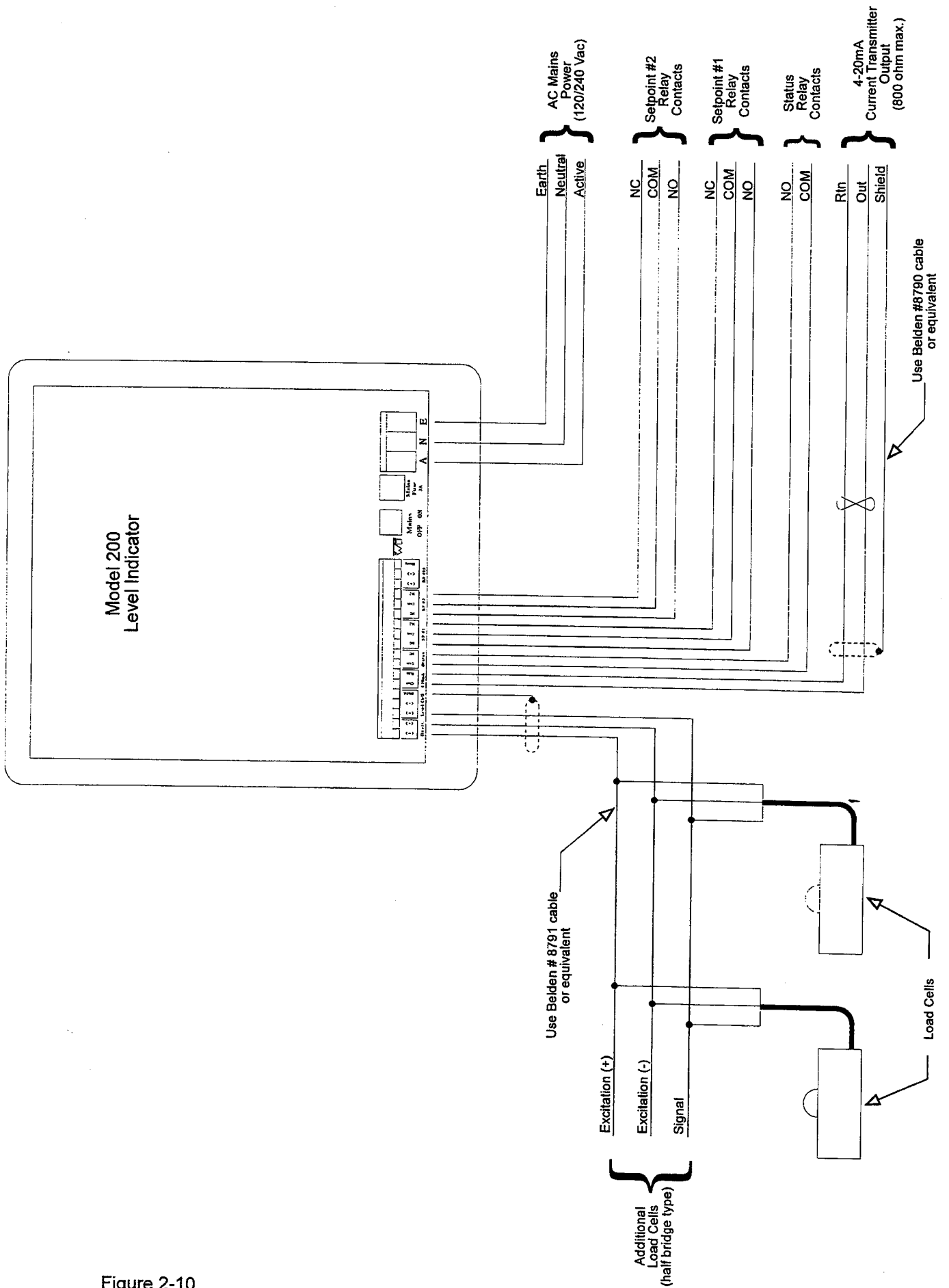

Figure 2-10

Model 200 Wiring Interconnect Diagram
(when using half bridge type load cells)

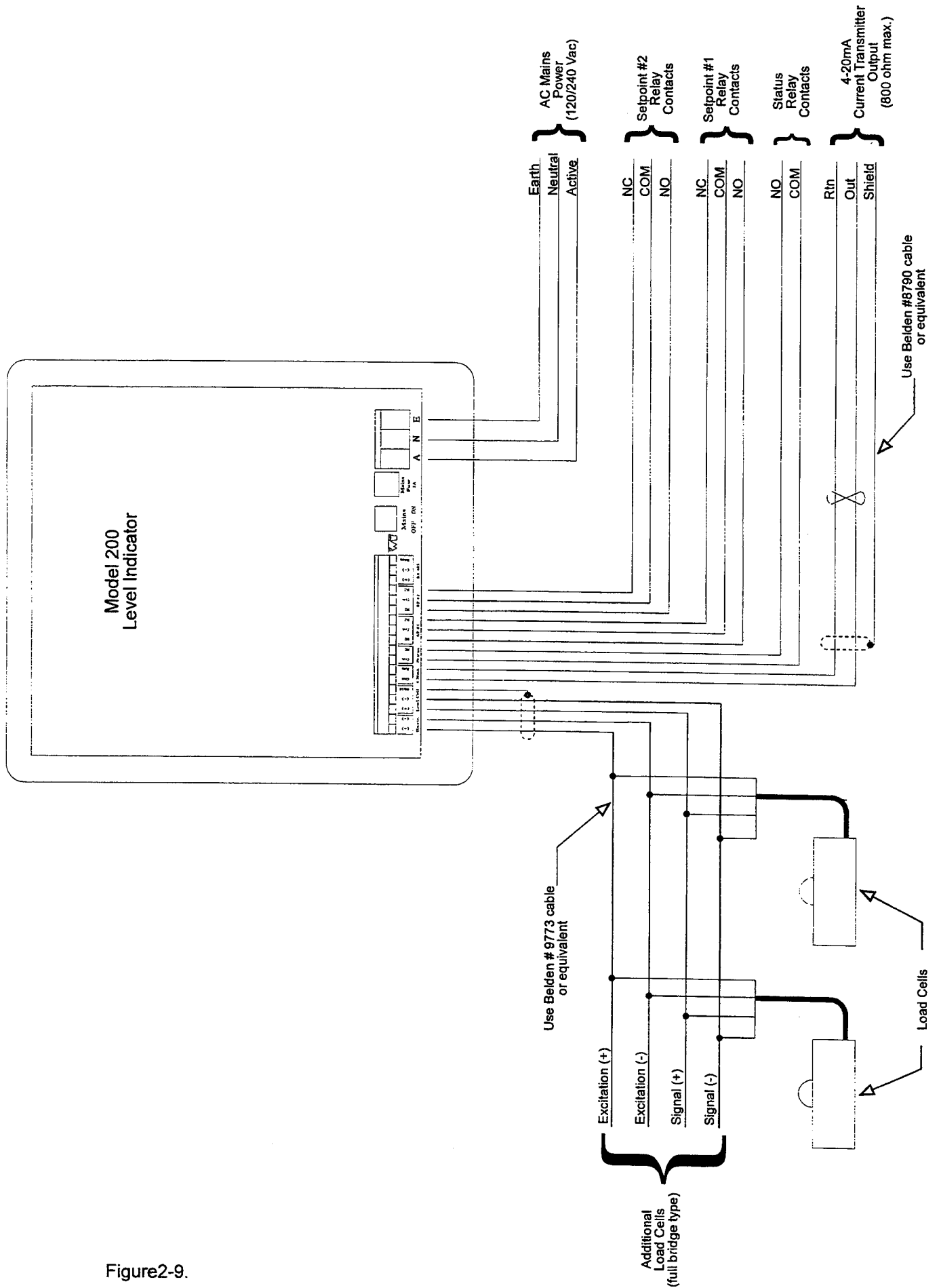

Figure2-9.

Model 200 Wiring Interconnect Diagram
(when using full bridge type load cells)

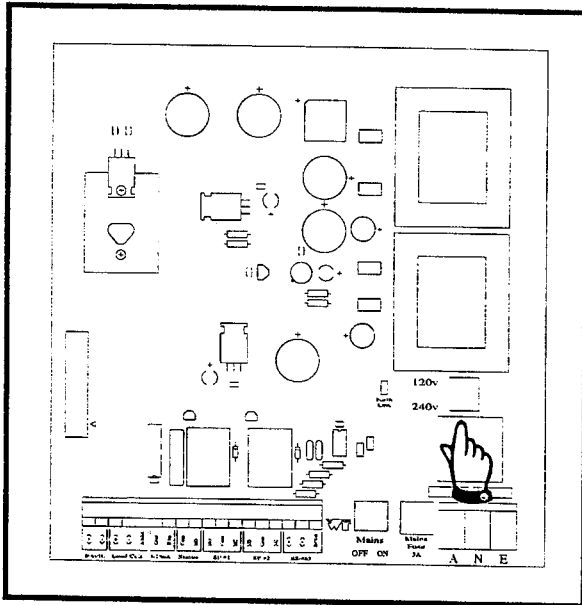

Figure 2-5
Mains Voltage Selection Switch on
Power Supply card

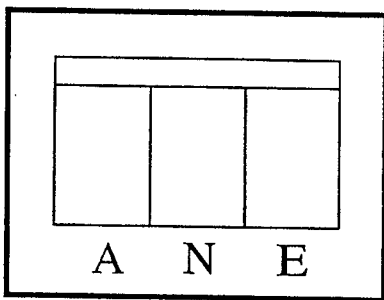

Figure 2-6
Mains Supply Terminal Block, TB1

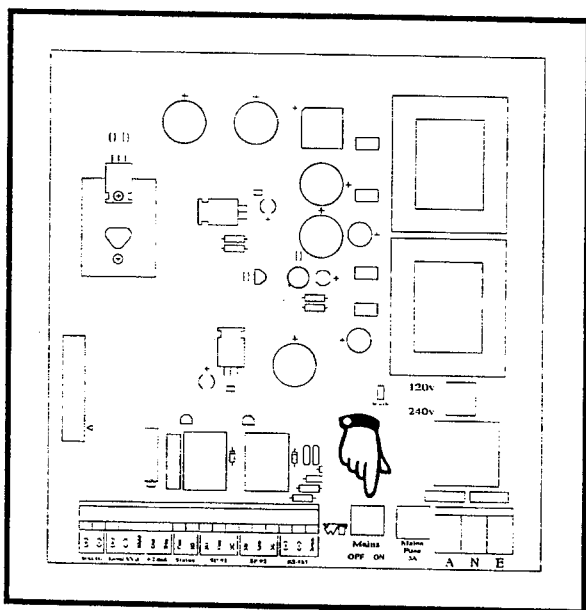

Figure 2-7
Mains ON/OFF Switch

To connect mains power to the instrument, proceed as follows.

- (a) Verify local mains supply voltage (i.e. 120Vac or 240Vac) and set voltage selector switch to reflect this voltage. See Figure 2-5 opposite.
- (b) Run power supply cable between the mains power source and the Model 200. Use cable of a suitable mains rating, for example, normal three core mains flex.
- (c) Connect power supply cable to the terminal block, TB1, in accordance with the legends located immediately below. Terminal block TB1 is located directly below the mains voltage selector switch shown in Figure 2-5.

The active wire should be connected to the terminal labelled **A**, while the neutral wire is connected to the terminal marked **N**. The earth lead from the power cable is connected to the terminal labelled **E**. Figure 2-6 shows the mains supply terminal block, TB1.

- (d) Check that the Mains ON/OFF switch is set to **OFF**. See Figure 2-7 opposite.
- (e) Turn **ON** mains supply at the source.
- (f) Turn **ON** the Mains ON/OFF switch. Check to see that the **+5v** indicator LED illuminates **ON** the **Menu Display** located on the CPU card as shown in Figure 2-8.

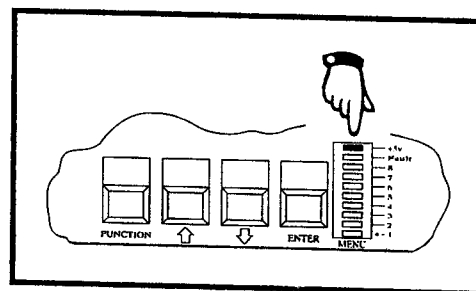

Figure 2-8
+5v Indicator LED on Menu Display

2.5 Connecting the Status Relay

A small system status relay is incorporated into the Model 200. This relay would typically be connected to a PLC and be used to signal the PLC of any notifiable faults with the Model 200 or a power failure. This relay would normally be energised in a fully functional instrument. In the event of a fault or power failure occurring, the status relay would de-energise.



The status relay has a contact rating of 20VDC @ 0.5A. Under no circumstances should mains power or any other high power supply be connected to this relay.

Connect the status relay output to the external monitoring device (e.g. PLC) as detailed below.

- (a) Run the interconnect cable between the external monitoring device and the Model 100. Use a cable suitable for use with the voltages and currents to be used.
- (b) Connect the interconnect cable to the terminal block, TB2, in accordance with the legends located immediately below.

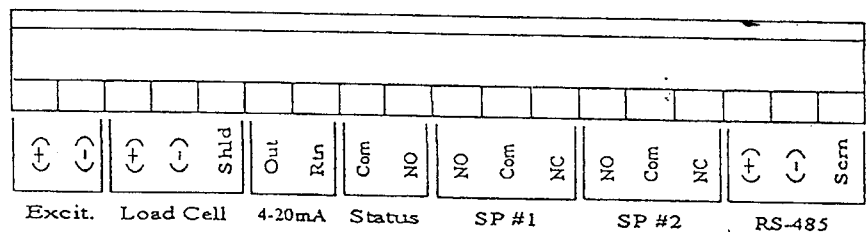

2.6 Connecting Mains Power

The Model 200 was designed as a dual voltage instrument and is therefore capable of operating from either 120Vac or 240Vac.



Do not turn on mains power until instructed to do so in the following procedure.

Before connecting the auxiliary equipment to the setpoint relays, some consideration should be given as to how this equipment is best controlled.

The setpoints operate such that the relays are de-energized when the bin level is at or below its respective setpoint. The relays become energized when the bin level is at or above a level equal to the setpoint plus hysteresis. The Model 200 has a hysteresis value of 1% pre-programmed at the factory.

For example, if a setpoint is programmed at 10% say, then the relevant relay will de-energise when the bin level drops to 10%. This relay will remain de-energized for all bin levels below 10%. If the bin is then filled, the relay will become energized when the level reaches 11%. The relay will then remain energized for all bin levels above 11%.

A detailed procedure for setting the setpoint levels, can be found in *Section 3.5 Programming of Setpoint Levels*.

Setpoint relay legends: NO - normally open contact
 NC - normally closed contact
 COM - common contact

Connect the auxiliary equipment to the setpoint relays as follows:

- (a) Run interconnect cable between the external equipment and the Model 200. Select a cable of sufficient rating so as to accommodate the power requirements of the equipment being connected.
- (b) Connect the interconnect cable to the terminal block, TB2, in accordance with the legends located immediately below.

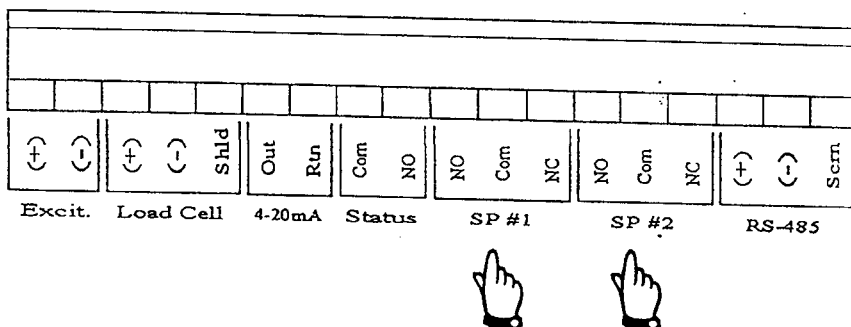

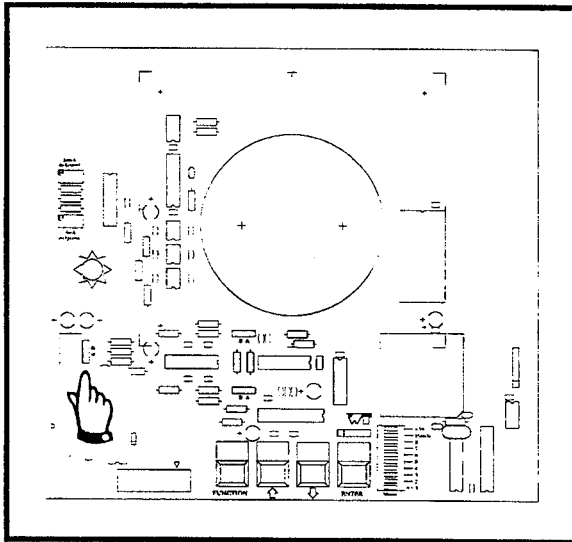

Figure 2-4
Full-Bridge/Half-Bridge Selection Link
(LK3 on CPU card)

NOTE: If using a half-bridge type load cell,
 ▼ connect the signal wire to the terminal marked **Load Cell (+)**. See Figure 2-11.

- (c) If using a half-bridge type load cell, ensure that the selection link LK3 on the CPU card is in position **B**. This link should be in position **A** for full-bridge type load cells. The location of LK3 is shown by Figure 2-4.

2.3 Connecting 4-20mA Current Loop

The 4-20mA current transmitter of the Model 200, provides a fully isolated industry standard current output capable of driving into a maximum loop load of 800 Ω .

Connect the current transmitter output to the external equipment as detailed below:

- (a) Run the interconnect cable between the external equipment and the Model 200. Use a suitable two core shielded cable such as **Belden 8790**.
- (b) Connect the interconnect cable to the terminal block, TB2, in accordance with the legends located immediately below.

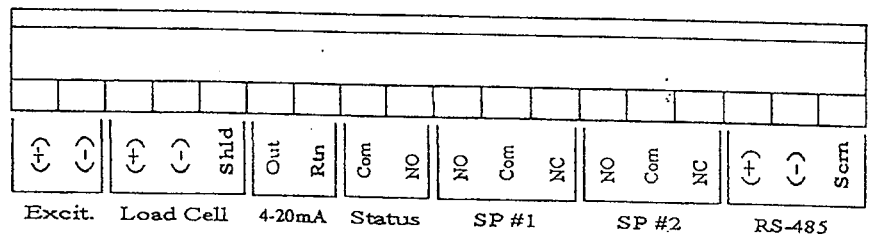

2.4 Connecting the Setpoint Relays

A standard feature of the Model 200, is the provision of two fully programmable setpoint relays to enable control of auxiliary equipment such as alarms, pump motors, etc.



The setpoint relays have a contact rating of 30VDC @ 10A and 240Vac @ 5A (resistive). Please ensure that the power requirements of the equipment connected to these relays do not exceed this rating.

2.1 Wiring Procedure

All connections to the Model 200 are made via the two terminal blocks shown in Figure 2-3 opposite. Terminal block TB1 accepts the AC power connections, while TB2 accommodates all other terminations. Refer to Figure 2-9, Figure 2-10 and Figure 2-11.

In order to maintain the IP66 (NEMA 4X) rating of the enclosure, suitable cable glands and fittings need to be used.



Care should be taken to ensure that all terminations are made in accordance with the following directions. Incorrect wiring may result in damage to the Model 200 and/or the attached equipment.

2.2 Connecting the Load Cell

The load cell is to be installed in accordance with the manufacturers' specifications and is therefore beyond the scope of this manual. Any queries regarding the load cell should be directed to the manufacturer.

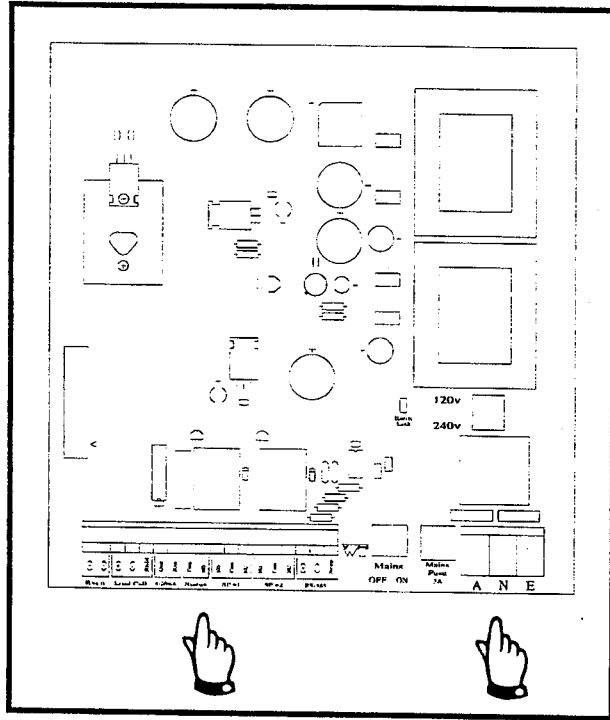
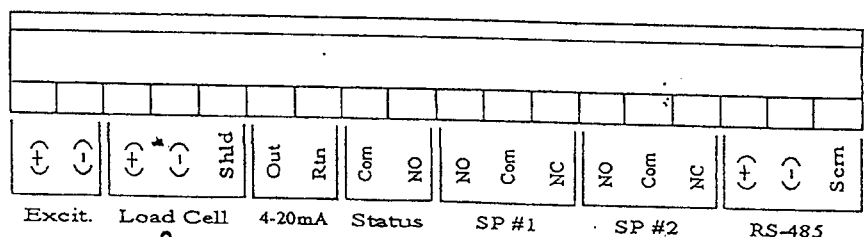

Figure 2-3
Terminal Blocks on Power Supply card

Connect the load cell to the Model 200 as follows:

- (a) Run interconnect cable between the load cell junction box and the Model 200. If using a half-bridge type load cell, use a suitable three core shielded cable such as **Belden 8791**. If using a full-bridge type load cell, use a suitable four core shielded cable such as **Belden 9773**.
- (b) Connect the load cell wires to terminal block TB2 in accordance with the legends located below the terminal block as shown below.



2.0 Mounting Instructions

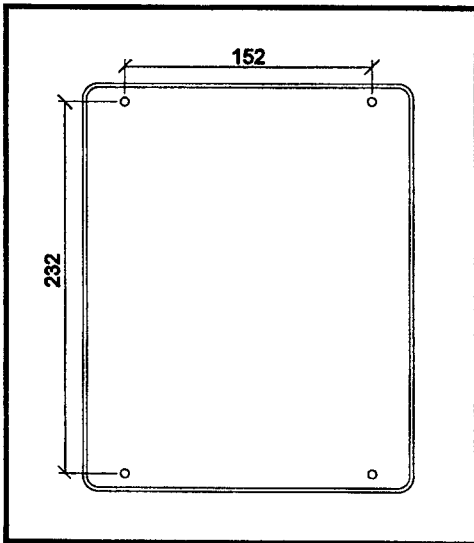

Figure 2-1
Standard Mounting Arrangement

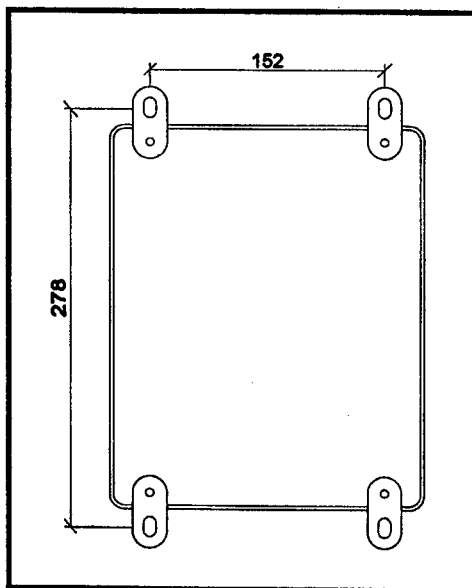

Figure 2-2
Mounting Arrangement Using Supplied
Mounting Kit

The Model 200 may be mounted by one of two methods. The mounting arrangement shown in Figure 2-1, is suitable for installations where the attaching screws can be inserted from behind the transmitter. Figure 2-2 shows the arrangement when using the supplied mounting kit. Either of these methods may be used without compromising the IP66 (NEMA 4X) rating of the enclosure.

The Model 200 has an operating temperature range of between -10°C and 50°C , when operated continuously. However, an installation location maintaining a temperature range of between 0°C and 50°C is preferred.

The transmitter should be wall mounted using the following procedure:

- (a) Select a mounting location which will provide sufficient clearance for the opening of the enclosure door, and allow cabling access to the bottom of the enclosure.
- (b) Decide upon which of the two mounting arrangements shown opposite, is the most suitable for your particular application. Drill holes in the wall using the dimensions shown in Figure 2-1 or Figure 2-2. The screws supplied in the enclosed mounting kit, (i.e. #10-32 pan head) can be used for the standard mounting arrangement detailed in Figure 2-1, providing the panel thickness does not exceed 3mm. If using the arrangement shown in Figure 2-2, you must supply the necessary hardware to attach the unit to the wall. The slots in the mounting feet supplied can accommodate screws up to 7mm in diameter.
- (c) Place the unit on the wall and attach using selected hardware. Care should be taken when screwing into the enclosure, to ensure that the torque applied to the screws does not exceed **2.7 Nm**.

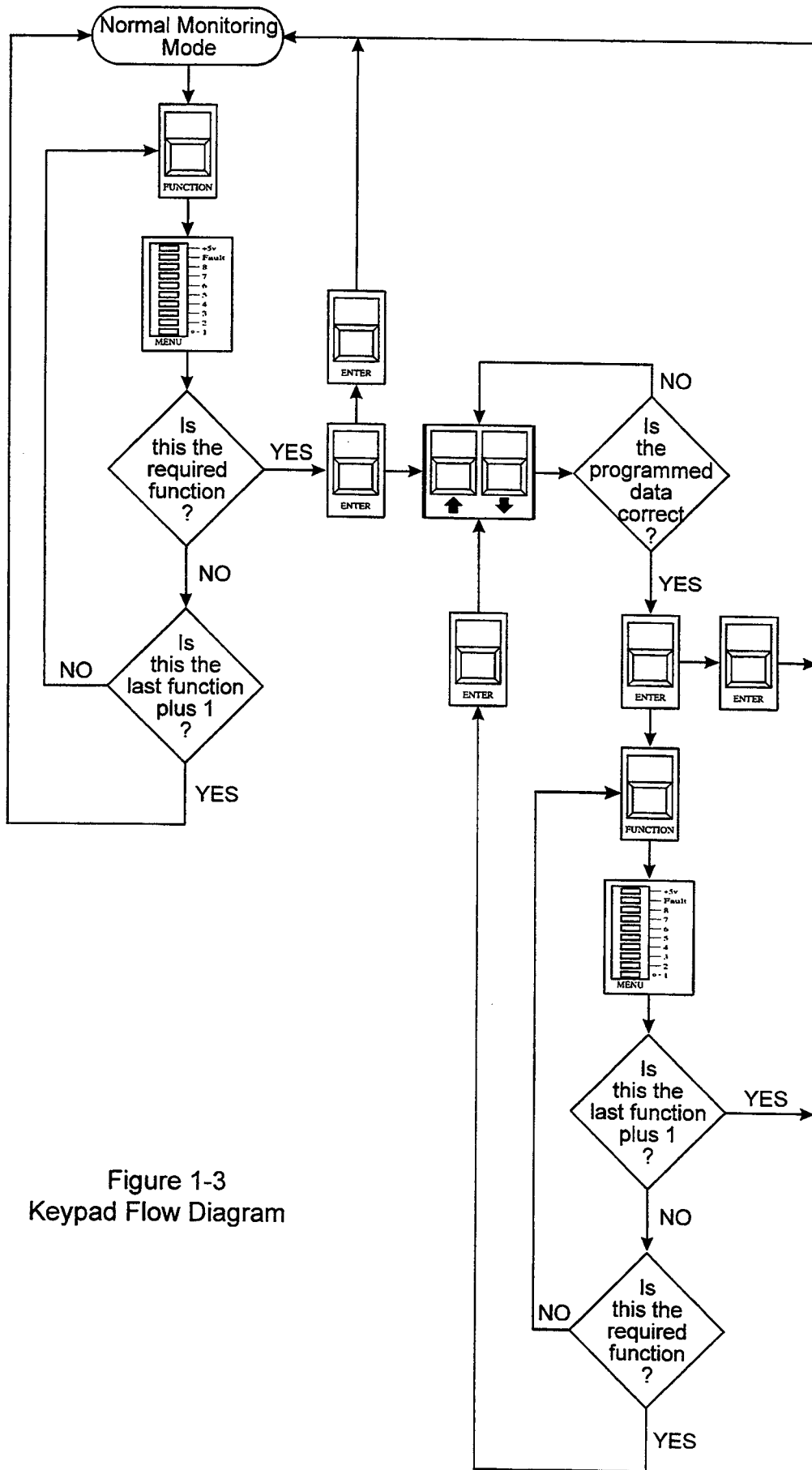



Figure 1-3 Keypad Flow Diagram

1.2.4 ENTER Key

The green **ENTER** key is used firstly, to confirm the selection of the desired function and secondly, to confirm the data input using the  and  keys.

Once the **ENTER** key has been pressed to store data, the Model 200 returns to the function selection mode enabling another function to be selected using the **FUNCTION** key as described earlier.

If the arrow keys have not been used, the **ENTER** key returns the Model 200 to its normal monitoring mode without changing data.

Pressing the **ENTER** key **TWICE**, causes the Model 200 to exit the function programming mode and return to its normal monitoring mode. The information just entered is used to recalibrate the transmitter at this point.

The two remaining segments are labelled **+5v** and **Fault**. The **+5v** segment indicates, when lit, the presence of the +5v electronics supply voltage, while the **Fault** segment illuminates when a problem exists with the current loop.



The **Menu** display also verifies correct operation of the microprocessor by scrolling continuously from top to bottom when not in the function programming mode. Failure of the display to scroll as just described, means that the microprocessor has ceased to operate. Should this situation ever occur, consult **Web-Tech** for technical support.

1.2.2 FUNCTION Key

The blue **FUNCTION** key, is used to scroll through the list of available functions as shown in Table 1-1.

Pressing this key once while in the normal monitoring mode, causes the **Menu** display to cease scrolling and illuminate the segment labelled 1. At this stage, the Model 200 is still in the monitoring mode and continues to monitor material levels, provide 4-20mA output signals and activate setpoint relays as appropriate. With each press, the next function segment is illuminated while the previous segment is extinguished. Upon reaching the last function segment, an additional press will cause the **Menu** display to recommence scrolling and the transmitter is returned to its normal monitoring mode of operation. The above sequence can be repeated by merely pressing the **FUNCTION** key again.

1.2.3 and Keys

The red  key and black  key are used, once in the function programming mode, to enter setup and calibration data.

Each press of either key, causes the particular function selected to be altered by approximately 0.25%. Holding these keys depressed for one second or more results in the function selected being updated at a rate of about 8% per second. The key is released when the desired input setting is reached.

1.2 Using the Keypad and Menu Display

The Model 200 level indicator uses a basic four key pad and simple LED bar graph display to perform all of the setup and calibration functions required. This combination ensures that all of these functions can be carried out simply and quickly. Figure 1-2 opposite shows the location and layout of the keypad and bar graph display.

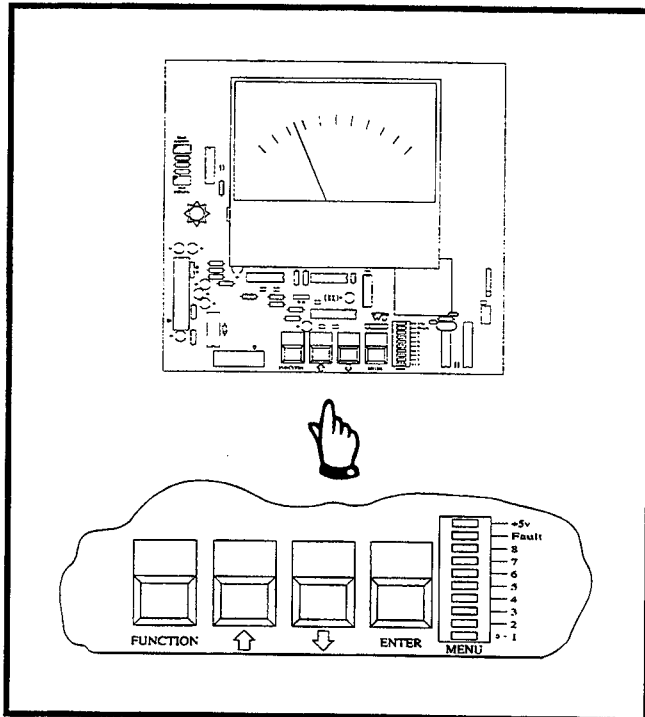

Figure 1-2
Keypad & Menu Display on CPU card

The keypad is used to scroll through and access the various functions and input calibration and setup information. The bar graph display is used, in conjunction with the keypad, to identify which function has been selected. The display also provides basic information on fault identification. The individual keypad functions and their relationship to the bar graph display, are detailed below. Figure 1-3 illustrates this relationship.

1.2.1 Menu Bar Graph Display

The **Menu** display is located just to the right of the keypad, and performs a number of tasks. Primarily, it serves to identify which programming function is currently selected. The bar graph consists of ten elements, eight of which are used to identify functions. These segments are numbered 1 to 8. The two remaining segments help to identify basic system problems, namely +5v power failure and current loop faults.

The eight numbered segments mentioned earlier, are used either individually or in combination to identify a particular function. This function/segment relationship is explained in Table 1-1.

Segment	Function
1	ZERO
2	SPAN
3	SETPOINT #1
4	SETPOINT #2
5	4mA ADJUST
6	20mA ADJUST
7	AUTO-ZERO ON/OFF
8	AUTO-ZERO THRESHOLD
1 & 2	AUTO-ZERO FAULT RESET
2 & 3	AUTO-ZERO MAX. CORRECTION
5,6,7 & 8	AUTO-ZERO FAULT

Table 1-1 Display segment/function assignments

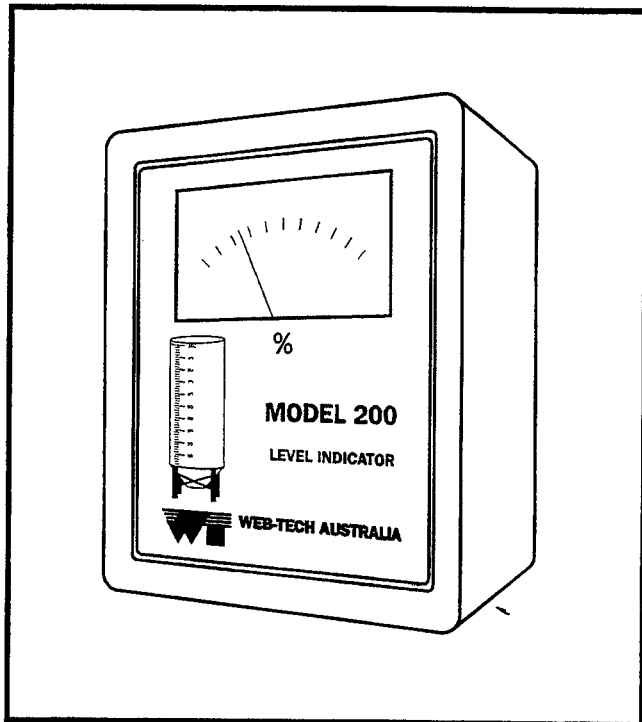

Figure 1-1
Model 200 Level Indicator

1.0 General Description

The Web-Tech Model 200 Level Indicator, is a microprocessor based instrument providing continuous measurement of material levels in silos and storage vessels for both new and existing applications. The instrument provides an indication of material level via an analogue meter graduated in 2% increments. The Model 200 also provides a 4-20mA current signal which is directly representative of the quantity of material in the vessel. A standard feature of the instrument, is the provision of two fully programmable setpoints, enabling the activation of external devices such as motors, pumps, alarms, etc. at predetermined material levels. Figure 1-1 illustrates the Model 200 Transmitter.

1.1 Standard Features

- # embedded Motorola 8 bit microprocessor
- # 20 bit A/D resolution
- # local analogue meter, graduated in 2% increments
- # isolated 4-20mA current loop (800 Ω max)
- # current loop fault indication
- # 12 bit D/A resolution on analogue output
- # two (2) fully programmable setpoints
- # system status relay output
- # accepts both full and half bridge load cells
- # X1 and X10 selectable gain settings on analogue input
- # easy programming of zero, span and setpoint levels
- # zero, span and setpoint levels retained indefinitely in non-volatile memory
- # 120/240Vac dual voltage operation
- # IP66 (NEMA 4X) rated enclosure, featuring a quick release lockable cover

Figure 3-8	SP#1 Function Indicator on Menu Display	27
Figure 3-9	SP#2 Function Indicator on Menu Display	27
Figure 3-10	Auto-Zero ON/OFF Indicator on Menu Display	31
Figure 3-11	Auto-Zero Threshold Adjustment Indicator on Menu Display	32
Figure 3-12	Auto-Zero Maximum Correction Indicator on Menu Display	33
Figure 3-13	Auto-Zero Fault Indicator on Menu Display	33
Figure 3-14	Auto-Zero Fault reset Indicator on Menu Display	34



List of Illustrations

Figure 1-1	Model 200 Transmitter	1
Figure 1-2	Keypad & Menu Display on CPU card ...	2
Figure 1-3	Keypad Flow Diagram	5
Figure 2-1	Standard Mounting Arrangement	7
Figure 2-2	Mounting Arrangement Using Supplied Mounting Kit	7
Figure 2-3	Terminal Blocks on Power Supply card	8
Figure 2-4	Full-Bridge/Half-Bridge Selection Link (LK3 on CPU card)	9
Figure 2-5	Mains Voltage Selection Switch on Power Supply card	12
Figure 2-6	Mains Supply Terminal Block, TB1	12
Figure 2-7	Mains ON/OFF Switch	12
Figure 2-8	+5v Indicator on Menu Display	12
Figure 2-9	Model 200 Wiring Interconnect Diagram (when using full bridge type load cells)	13
Figure 2-10	Model 200 Wiring Interconnect Diagram (when using half bridge type load cells)	14
Figure 2-11	Model 200 Wiring Interconnect (when using Microcells)	15
Figure 3-1	Connect Ammeter to 4-20mA Output ...	17
Figure 3-2	4mA Calibration Indicator on Menu Display	17
Figure 3-3	4mA and 20mA Adjustment Potentiometers on CPU card	18
Figure 3-4	20mA Calibration Indicator on Menu Display	18
Figure 3-5	Location of Gain Links on CPU card	19
Figure 3-6	ZERO Function Indicator on Menu Display	20
Figure 3-7	SPAN Function Indicator on Menu Display	21

3.6	Programming of Setpoint Levels	26
3.7	4-20mA Current Transmitter Alignment	28
3.8	Auto-Zero Setup	30
3.8.1	Auto-Zero ON/OFF	30
3.8.2	Auto-Zero Threshold Adjustment	31
3.8.3	Auto-Zero Maximum Correction Adjustment	32
3.8.4	Resetting Auto-Zero Fault	34
Appendix A. WEB-TECH Offices		36
Appendix B. Product Specifications		37

Table of Contents

Chapter 1. Introduction

1.0 General Description	1
1.1 Standard Features	1
1.2 Using the Keypad and Menu Display	2
1.2.1 Menu Bar Graph Display	2
1.2.2 FUNCTION Key	3
1.2.3  and  Keys	3
1.2.4 ENTER Key	4

Chapter 2. Installation

2.0 Mounting Instructions	7
2.1 Wiring Procedure	8
2.2 Connecting the Load Cell	8
2.3 Connecting 4-20mA Current Loop	9
2.4 Connecting the Setpoint Relays	9
2.5 Connecting the Status Relay	11
2.6 Connecting Mains Power	11

Chapter 3. Calibration

3.0 Calibration Procedure	16
3.1 4-20mA Current Transmitter Calibration	17
3.2 Load Cell Amplifier Gain Adjustment	19
3.3 ZERO and SPAN Calibration (optimum)	19
3.3.1 ZERO Calibration	20
3.3.2 SPAN Calibration	21
3.4 ZERO and SPAN Calibration	22
(by adding a known quantity of material)	
3.5 ZERO and SPAN Calibration	24
(by removing a known quantity of material)	

Product Specifications

Enclosure

NEMA 4X Fibreglass

Dimensions 267 x 216 x 158 mm.

Mounting Suitable for wall mounting only.

Shipping Weight

Power Requirements

Mains Supply* 240V AC \pm 10%, 50-60 Hz.

..... 117V AC \pm 10%, 50-60 Hz.

* Mains supply voltage is switch selectable.

Load Cell Excitation

Voltage 10 volts DC, fixed.

Current 200mA, internally limited.

Load Cell Input

Range -1 to +1 volt.

Resolution 20 bits.

Type Will accept both full-bridge and
..... half-bridge type load cells.

Display

Analogue Meter 0-100% in 2% increments

Analogue Output

4-20mA current transmitter Fully isolated, internal loop supply
..... 800 ohm max. loop resistance.

Setpoint Relay Outputs

Quantity two, identical.

Programmable range 0 - 100%.

Contact rating 240V AC @ 5A, resistive.

..... 30V DC @ 10A, resistive.

Status Relay Output

Contact rating 20V DC @ 0.5A, resistive.

Environmental

Temperature -10°C to 50°C, when operated
..... continuously.

..... 0°C to 70°C, cold start.